



## CombBind C340 & C450E

- Ⓒ *GB* **Instruction Manual**
- Ⓒ *F* **Manuel d'utilisation**
- Ⓒ *D* **Bedienungsanleitung**
- Ⓒ *I* **Manuale d'istruzioni**
- Ⓒ *NL* **Gebruiksaanwijzing**
- Ⓒ *E* **Manual de instrucciones**
- Ⓒ *P* **Manual de Instruções**
- Ⓒ *TR* **Kullanım Kılavuzu**
- Ⓒ *GR* **Οδηγίες**
- Ⓒ *DK* **Brugsvejledning**
- Ⓒ *FI* **Käyttöopas**
- Ⓒ *NO* **Bruksanvisning**
- Ⓒ *S* **Bruksanvisning**
- Ⓒ *PL* **Instrukcja obsługi**
- Ⓒ *CZ* **Návod k obsluze**
- Ⓒ *H* **Használati útmutató**
- Ⓒ *RUS* **Руководство по эксплуатации**



**ATTENTION**

To register and activate  
the warranty go to  
[www.accoeurope.com](http://www.accoeurope.com)

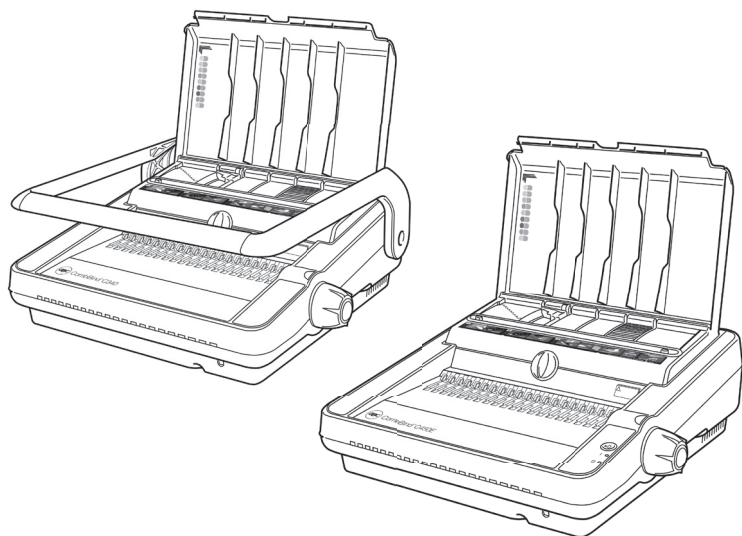

<b>English</b>	<b>4</b>
<b>Français</b>	<b>8</b>
<b>Deutsch</b>	<b>12</b>
<b>Italiano</b>	<b>16</b>
<b>Nederlands</b>	<b>20</b>
<b>Español</b>	<b>24</b>
<b>Português</b>	<b>28</b>
<b>Türkçe</b>	<b>32</b>
<b>Ελληνικά</b>	<b>36</b>
<b>Dansk</b>	<b>40</b>
<b>Suomi</b>	<b>44</b>
<b>Norsk</b>	<b>48</b>
<b>Svenska</b>	<b>52</b>
<b>Polski</b>	<b>56</b>
<b>Česky</b>	<b>60</b>
<b>Magyar</b>	<b>64</b>
<b>Русский</b>	<b>68</b>

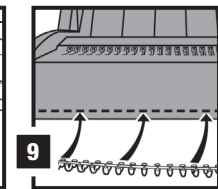
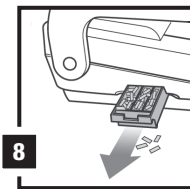
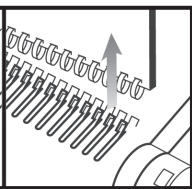
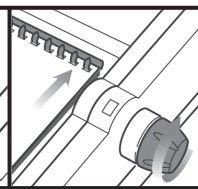
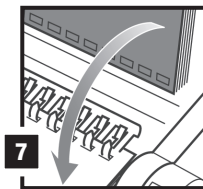
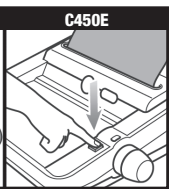
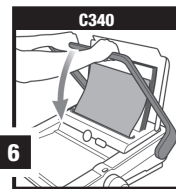
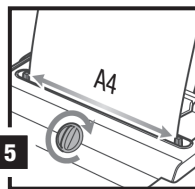
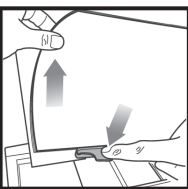
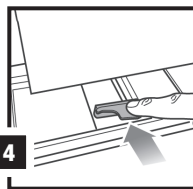
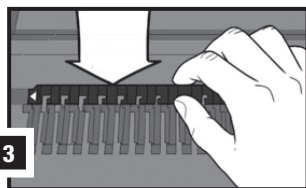
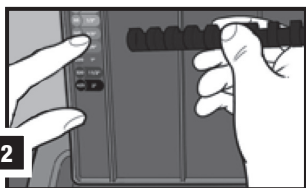
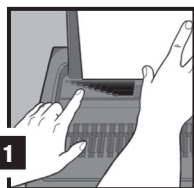
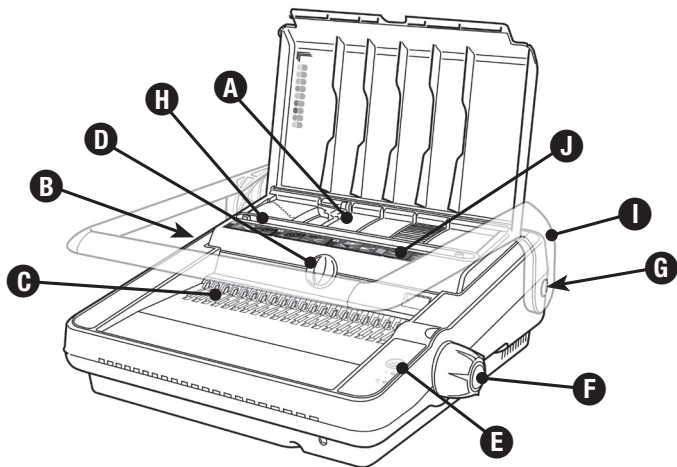

**10 Quickstart Guide 1-2-3**

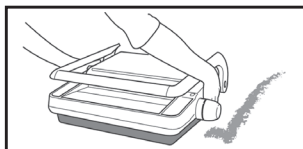

## Specifications

	GBC CombBind C340	GBC CombBind C450E
Operation mode	manual	electric
Max. binding size	A4	A4
Hole pitch	US Pitch 9/6" / 14.28mm	US Pitch 9/6" / 14.28mm
Number of punch slots	21	21
Margin depth	fixed	fixed
Punching paper (80gsm)	max. 25	max. 25
Punching PVC plastic foils (0.2mm)	max. 3	max. 3
Max. comb diameter	51mm	51mm
Binding capacity	450 sheets	450 sheets
Net weight	10.45kg	15.6kg
Dimensions WxDxH	440x450x200mm	440x450x170mm
Voltage	n/a	230V 50Hz AC

CE C450E is approved to EN60950 and CE Standards.  
Technical data subject to change without notification.

## Special notice

Thank you for choosing a GBC Binding machine. We aim to produce quality binding machines at an affordable price, with many advanced features to enable you to create excellent results every time. Before using your machine for the first time, please take a few minutes to read through this guide and retain these instructions for future reference.

## Safety instructions

YOUR SAFETY AS WELL AS THE SAFETY OF OTHERS IS IMPORTANT TO ACCO BRANDS EUROPE. IN THIS INSTRUCTION MANUAL AND ON THE PRODUCT ARE IMPORTANT SAFETY MESSAGES. READ THESE MESSAGES CAREFULLY.

- In order to avoid overloading your machine, please refer to the maximum punch guide located on the front of your machine before punching.
- When punching PVC/PP covers, we recommend the cover be punched with some paper either side.
- DO NOT punch metallic objects such as staples or paper clips.
- Please empty the waste tray regularly.
- Ensure that the machine is operated on a flat stable surface.
- Never lift the machine by the punching handle. Always use the hand grips located on the side of the machine.
- The binder is not to be exposed to temperature / humidity conditions that would cause condensation. Maximum ambient temperature ~40°C.

## Location of controls

- A** Document separator
- B** Clippings tray  
(located at side of machine)
- C** Comb opening teeth
- D** Paper centering dial
- E** Electric punch button (C450E only)
- F** Comb opening knob
- G** On/Off switch (C450E only)
- H** Punching slot
- I** Punching handle (C340 only)
- J** Quick start guide

## Safety tips - C450E

- DO NOT obstruct air inlets and outlets.
- DO NOT use the binder if the power cord (mains cable) is damaged.
- DO NOT place the power cord where it may be tripped over or pulled. Ensure it does not come into contact with hot surfaces such as pipes or radiators. Make sure the cable is not squashed or pinched.
- DO NOT use an extension cable unless it is absolutely necessary and then only use one of a suitable current rating (10A or greater).
- DO NOT leave the binder connected to the electricity supply when not in use.
- DO NOT immerse the binder in water or other liquids. Doing so will result in ELECTRIC SHOCK.
- DO NOT attempt to disassemble the binder. Always consult a qualified person.
- The noise emitted by the machine does not exceed 70 dB.

## Maintenance options

- If you would like to extend your warranty coverage beyond the stated manufacturers period, please consult your local ACCO Brands Europe reseller for options.

## Setting up

- Your machine is ready to use when removed from the box. Retain the packaging in case you need to return the machine for repair.
- The punching mechanism is coated with a protective film of lubricant, which will mark your paper. Clear this by punching scrap sheets of paper until clean prior to binding.

## Comb binding instructions

Each step relates to the illustrations throw-out at the front of this manual.

Please open the quick start guide, located at the front of the machine for reference.

## 1. Binding

- 1 Lift the lid and punch handle to the upright position.
- 2 Place entire document so it rests on the lid.
- 3 **Measure document using colour coded guide (fig.1)**  
Open the lid of the machine and rest your document (including any cover sheets you have chosen) against the lid on the 'staging' area provided. Gently push the document back against the lid and check the document size using the colour coded guide on the staging area. You can leave your document on the staging area in readiness to punch.
- 4 **Select comb which fits your document (fig.2)**  
Use the comb size guide to select the size of comb that fits your document i.e. 25 sheet document = 6mm comb.

## Setting up - C450E

- Connect the binder to the electricity supply with the power cord supplied.
- Switch ON using the ON/OFF switch located at the rear of the binder by the power inlet socket.
- Wait while the binder goes through an automatic check procedure, both LED's light up.
- When complete the green LED will remain ON.
- The binder is ready for operation.



**WARNING: This appliance MUST be earthed. If in doubt consult a qualified electrician.**

### 5 Load comb onto machine (fig.3)

Insert the binding comb next to the white positional arrow on the machine, behind the metal comb support fingers, with the open side of the comb pointing upwards.

**Note:** If using GBC ProCombs™ the white arrow on your comb should align to the white arrow on the machine.

### 6 Open comb by turning lever towards you

The coloured arrows adjacent to the opening comb act as a guide as to how far to open in order to allow punched sheets to be easily inserted.

Rotate the binding lever toward you until the comb binding element opens sufficiently to insert your document.

## Guarantee

Operation of this machine is guaranteed for two years from date of purchase, subject to normal use. Within the guarantee period, ACCO Brands Europe will at its own discretion either repair or replace the defective machine free of charge. Defects due to misuse or use for inappropriate purposes are not covered under the guarantee. Proof of date of purchase will be

Register this product online at [www.accoeurope.com](http://www.accoeurope.com)

required. Repairs or alterations made by persons not authorised by ACCO Brands Europe will invalidate the guarantee. It is our aim to ensure that our products perform to the specifications stated. This guarantee does not affect the legal rights which consumers have under applicable national legislation governing the sale of goods.

## 2. Sort paper (fig.4)

- 1 To manage large documents use the document separator.
- 2 Push the separator into the document.
- 3 Lift the separator upwards to reveal the first stack of paper ready for easy punching.

## 3. Set paper size (fig.5)

- 1 On manual machines, always ensure the punch handle is in the upright position before centering the paper.
- 2 Load the first paper stack into the punch slot.
- 3 Centre the paper using the dial located at the front of the machine (fig.5).
- 4 Adjust the machine by sliding the switch located at the front of the machine from A4 to A5.

## 4. Punch & bind

**For manual punching:** Lower the raised handle until the paper is punched, and support the machine when lifting the handle to the upright position (fig.6).

**For electric punching:** Press the 'punch button' located on the right panel of the machine (fig.6).

**Note:** If the machine is overloaded and fails to complete the punch cycle, the red LED will be lit. Press the 'punch button' to cancel the red LED. If this does not work contact the service helpline.

- 1 Place the front cover (finished side down) onto the opened binding element fingers. Place the document pages (face down) onto the element. Repeat for larger documents as required. Place the back cover (finished side up) on the open binding element fingers last.
- 2 Rotate the binding lever away from you, back to its original position to close the binding element.
- 3 Remove the book by lifting upward. Your document is now complete.

## Binding tips

- Load the rear cover onto the open comb first, followed by the internal sheets and front cover.
- To edit your document, additional sheets may be included or removed by placing your document (comb open side up) onto the metal teeth and following instructions again.
- For further hints and tips please visit our website: [www.gbceurope.com](http://www.gbceurope.com)

## Quickstep Guide 1-2-3 (fig.10)

The QuickStep Guide label on the machine is a quick reference guide to how to bind in three quick and simple steps.

- 1 Understand the comb size required by measuring on the document size area 1, select the appropriate ProComb.
- 2 Load the ProComb with the dot to the left and open until you see the coloured arrow.
- 3 Punch and load your document on to the spine until your document is complete. Close the spine.

## ZipComb spine (fig.9)

The ZipComb spine allows you to create an easily editable document with comb punch orientation.

- 1 Place spine on to ZipComb holder (fig.9).
- 2 Load and punch paper as per 'Punch & bind', section 4.
- 3 Load punched paper on to spine.
- 4 Remove document and spine, close the ZipComb using the zipper included in the ZipComb boxes.
- 5 Complete by flipping the back cover around the spine, for a professional finish where the spine is hidden.

## Security



A security slot is fitted for use with leading makes of security leash. E.g. Kensington Microsaver.

## Maintenance

Please ensure the clippings tray is emptied on a regular basis. This may prevent your machine from overloading (fig.8).

### C340:

When the clippings tray is full, you will see the clear window full of clippings. Empty the contents of the tray to continue binding.

### C450E:

When the clippings tray is full, a yellow LED will be lit. Empty the contents of the tray to continue binding.

## Troubleshooting

- This machine has a recommended duty cycle of 5 operations per minute, up to a maximum of 30 minutes on / 30 minutes off.
- This machine is fitted with a thermal overload safety feature. In extreme circumstances, the motor may overheat which will activate the safety feature. This feature will prevent the machine punching until it has cooled sufficiently.
- The thermal overload switch will automatically reset after approximately 15 minutes. The machine will then operate as if it had been overloaded.