



ThermaBind T200

- Ⓒ *Instruction Manual*
- Ⓕ *Manuel d'utilisation*
- Ⓓ *Bedienungsanleitung*
- Ⓘ *Manuale d'istruzioni*
- Ⓝ *Gebruiksaanwijzing*
- Ⓔ *Manual de instrucciones*
- Ⓟ *Manual de Instruções*
- Ⓣ *Kullanım Kılavuzu*
- Ⓖ *Οδηγίες*
- Ⓓ *Brugsvejledning*
- Ⓕ *Käyttöopas*
- Ⓝ *Bruksanvisning*
- Ⓢ *Bruksanvisning*
- Ⓟ *Instrukcja obsługi*
- Ⓒ *Návod k obsluze*
- Ⓕ *Használati útmutató*
- Ⓒ *Руководство по эксплуатации*



ATTENTION

To register and activate
the warranty go to
www.accoeurope.com

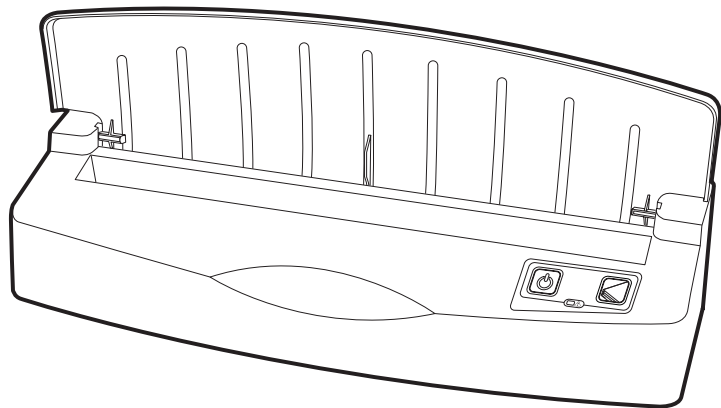

English	4
Français	5
Deutsch	6
Italiano	7
Nederlands	8
Español	9
Português	10
Türkçe	11
Ελληνικά	12
Dansk	13
Suomi	14
Norsk	15
Svenska	16
Polski	17
Česky	18
Magyar	19
Русский	20



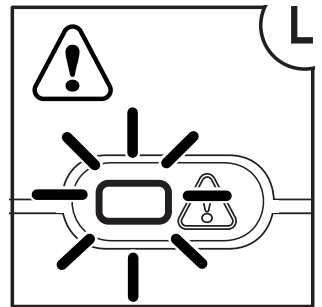
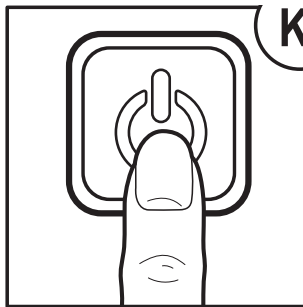
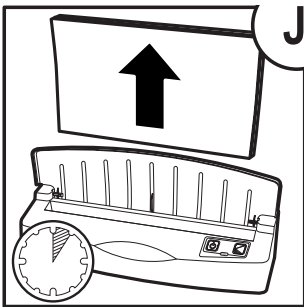
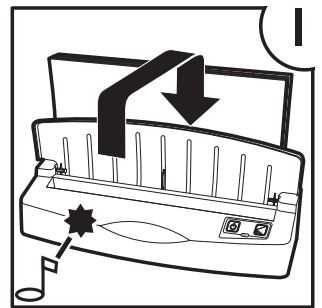
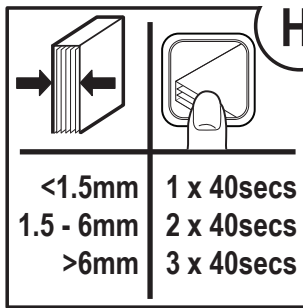
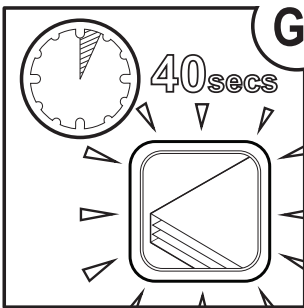
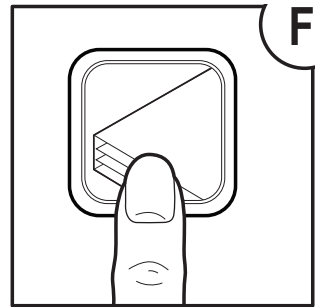
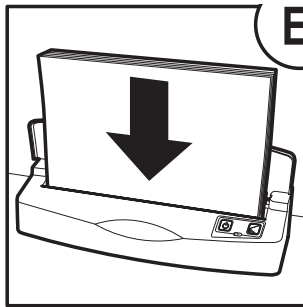
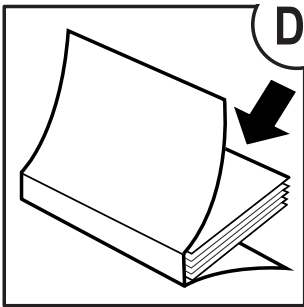
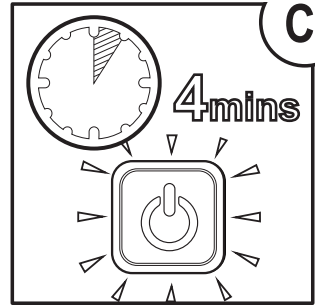
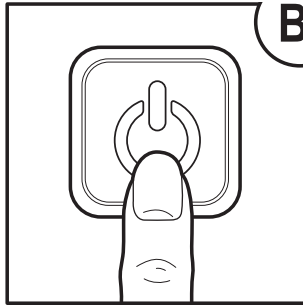
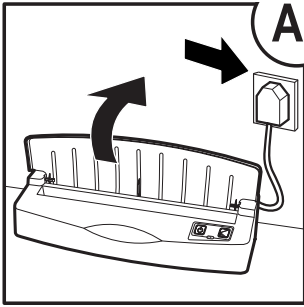



Please read and keep these important safety instructions

For a copy of the operating instructions, hints and tips, and troubleshooting guide, please visit www.gbceurope.com

- Only use the unit for its intended purpose.
- Do not touch the heating plate of this unit as it may be hot.
- Do not close the lid when the machine is in use.
- The unit must only be connected to a supply voltage corresponding to the electrical rating shown on the unit.
- Unit should be connected to a socket outlet near the equipment that is easily accessible.
- Do not connect to multi adaptors or use with an extension cable.
- Failure to follow these instructions could result in damage/injury and will invalidate your guarantee.
- Do not attempt to service or repair the unit yourself.
- In the event of a fault, unplug the unit and contact your retailer or distributor.
- Do not use this unit if the cable or plug have been damaged.

Warning! – If the red LED lights up, do not use the unit. Unplug immediately from the wall socket and contact your local service centre (L).

Guarantee

Operation of this machine is guaranteed for two years from date of purchase, subject to normal use. Within the guarantee period, ACCO Brands Europe will at its own discretion either repair or replace the defective machine free of charge. Defects due to misuse or use for inappropriate purposes are not covered under the guarantee. Proof of date of purchase will be required. Repairs or alterations made by persons not authorised by ACCO Brands Europe will invalidate the guarantee. It is our aim to ensure that our products perform to the specifications stated. This guarantee does not affect the legal rights which consumers have under applicable national legislation governing the sale of goods.

Waste Electrical and Electronic Equipment (WEEE)

At the end of its useful life, your product is considered to be WEEE. As such, it is important to note that:

WEEE is not to be disposed of as unsorted municipal waste. It is to be collected separately such that it can be disassembled so its components and materials can be recycled, re-used, and recovered (burned for energy content in the production of electricity).

Public collection points have been set up by municipalities for the collection of WEEE, free of charge to you.

Please return your WEEE to the collection facility nearest your home or office.

If you have difficulty locating a collection facility, the retailer that sold you the product should accept your WEEE.

If you are no longer in contact with your retailer, please contact ACCO for assistance with this matter.

Recycling of WEEE is geared toward protecting the environment, protecting human health, preserving raw materials, improving sustainable development, and ensuring a better supply of commodities in the European Union. This will be achieved by retrieving valuable secondary raw materials and reducing the disposal of waste. You can contribute to the success of these goals by returning your WEEE to a collection facility.

Your product is marked with the WEEE symbol (wheelie bin with an X through it). This symbol is to inform you that the WEEE is not to be disposed of as unsorted municipal waste.